

PROXXON

Tools with Character!



Edition 2012



PROXXON
INDUSTRIAL



Manufactured in the world's largest socket and spanner factory, utilising the most modern production techniques.

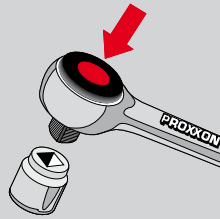

Quick release button releases socket instantly:

A feature you will appreciate every day.

DIN
ISO

Quality at its best:

Highest quality, exceeds DIN/ISO requirements for hardness and maximum torque. Individual size tolerances are all well within the prescribed norms.

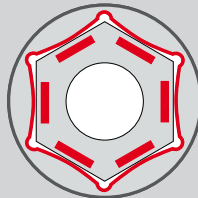

The PROXXON driver system:

The driving force is applied to the flanks, not the corners. This ensures high power transmission without damaging the corners of the nut or bolt.

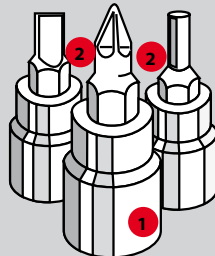

Screwdriver bits:

With CrV socket **1**. The drive bits are all an optimum combination of chrome-silicon manganese-molybdenum steel **2**.

All bits and accessories are forged using 31CrV steel. High carbon content to ensure consistent hardness. **3** Deep, uniform forging is fully guaranteed on the hex. drive side **4** to ensure that protruding studs do not present a problem. Thin-wall construction **5** for better access while maintaining strength for heavy work. Lead-in chamfer allows socket to slide over nuts easily. Machined fits on drive square **6** allow ratchet to arrest properly. Beginning with the 19mm size the outer diameter **7** of the sockets is reduced on the drive square end for improved handling **8**. Optimum surface protection: Double nickel-plating and single matt-finished chrome-plating.

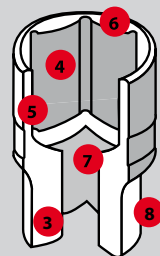

Inseparable handle of oil and acid-resistant TPR (thermoplastic rubber). With hole for hanging.



Socket sizes easy to read due to laser marking!

2 year guarantee

For full professional use!

Sockets and drive elements carry an additional **25 year guarantee** against faulty material and workmanship.



The heart of a socket set: The ratchet.

With push button socket release.



The Ratchet:

is made from one single piece, i.e. the head is not welded on **1**. Quick release button releases socket instantly when pressed **2**. Perfect teeth, suitably hardened for maximum life expectancy **3**. Reliable drive direction mechanism simultaneously engages numerous teeth to ensure optimal torque transmission **4**.

Sturdy, welded steel box, powder coated for durability. With strong moulded plastic insert for the secure placement of each item. The table for the bolt \varnothing from M 1.6 – M 24 with the related tightening torques and socket sizes are printed on the inside of the lid.



**Socket set for heavy duty mechanics.
From 8 – 34mm, 29-piece set.**

With 1/2" (12.5mm) square drive and 34mm socket (M 22 according to the new ISO standard). Includes deep sockets for protruding bolts. Plus 16 and 21mm spark plug sockets. [See photo for full contents.](#)

NO 23 000

Inseparable handle of oil and acid-resistant TPR (thermoplastic rubber). With hole for hanging.



Socket sets in chrome vanadium steel.

Standard range in sturdy, powder coated steel boxes.



56 piece set with 1/4" and 1/2" ratchets.

Contains sockets from 4mm to 32mm and 16/21mm spark plug sockets, screwdriver bits with square drive for slotted, Phillips, TORX (with frontal hole) and Allen sockets and 1.25 – 1.5 – 2.0 – 2.5 and 3mm angled Allen keys.

[See photo for full contents.](#)

NO 23 040



Automotive socket set with 1/4" and 1/2" ratchets, 27 piece set.

Suitable for all common sizes between 6mm and 32mm. Also contains 16 and 21mm spark plug sockets.

[See photo for full contents.](#)

NO 23 020



Compact set with 3/8" ratchet, for 6 – 24mm sockets, 24 pieces.

Set includes 16, 18 and 21mm spark plug sockets.

[See photo for full contents.](#)

NO 23 110



Special set for XZN multi-toothed screws, 18 pieces.

For motor (cylinder head), drive shafts, rear axles. Includes 1/2" square drive. Screwdriver bits 5 – 14mm in normal version (55mm) and 6 – 14mm in extra-long version (100mm). Also includes outside double-hexagon inserts 9 – 21mm.

NO 23 296

High quality tools for industry,

workshop and construction.

New:

Screwdriver handle with 1/4" square drive and adapter in handle to fit a ratchet or a T-bar.



Precision engineer's set with 1/4" ratchet, 36-piece set.

Includes 4 – 13mm sockets, screwdriver bits with square drive for slotted, Phillips, TORX (with frontal hole) and Allen sockets as well as 1.25 – 1.5 – 2.0 – 2.5 and 3mm angled Allen keys. Just compare the value for money.

[See photo for full contents.](#)

NO 23 080



39 piece screwdriver/socket set with magnetic adapter.

For use with a drilling machine: 4 – 14mm sockets 1/4" drive (6.3mm). Includes 16 high quality alloy Allen key bits and adapters for male hex and square bits (magnet to socket adapter) and female hex and square bits (ratchet to screwdriver bit adapter) and 1.25 – 1.5 – 2.0 – 2.5 and 3mm angled Allen keys.

[See photo for full contents.](#)

NO 23 070



23 piece TORX socket set.

This set contains 1/4" drive (6.3mm) TORX sockets in sizes TX8 to TX30 (with frontal hole) and external TORX sizes E4 to E8 (all suitable for tightening torques up to 10Nm), 1/2" drive (12.5mm) TORX sockets in sizes TX40 – 60 and external TORX E10 to E18 (for tightening torques from 25 to 135Nm) and three offset TORX spanners – the TX6, 8 and 10.

[See photo for full contents.](#)

NO 23 102



Compact Screwdriver set of 28 pieces with 1/4" drive. Suitable for all bikers.

Screwdriver handle with 1/4" square drive (6.3mm) for direct drive of sockets. The rear of the handle is supplied with a square hole, accepting the extension as additional lever. The bits are all of high quality special steel and the TX items are fitted with a frontal hole.

[See photo for full contents.](#)

NO 23 072



Special set for Allen screws, 18-piece set.

For 1/4" square drive (6.3mm) and tightening torques up to 25Nm. Sizes 2 – 6mm.

For 1/2" square drive (12.5mm) and tightening torques from 25 – 210Nm: sizes 6 – 14mm (short version 55 mm) and sizes 5 – 12mm (long version 100mm).

[See photo for full contents.](#)

NO 23 100

Note: Our super safety and specialty bit set (75-piece) is described in detail on page 26 of this catalogue.



The alternative: 6 popular socket sets in compact and solid plastic case.

With sliding lock and sturdy tray. Each part to be taken out with two fingers. No clamping!

PROXXON

INDUSTRIAL



Now with 34mm socket (according to new ISO standard for M 22).

Composition and design copyright by PROXXON.

Complete set with 1/4" and 1/2" baton ratchets.

This 65 piece set offers sockets from 4 to 34mm, as well as 16 and 21mm spark plug sockets. Screwdriver bits with square driver for slotted, Phillips, TORX (with frontal hole) and Allen sockets. Angled Allen keys 1.25 – 1.5 – 2.0 – 2.5 and 3mm. Four extensions, one screwdriver handle with square drive, two universal joints. Screwdriver handle with square drive for slotted, Phillips, TORX and Allen sockets. [See photo for full contents.](#)

NO 23 286

Complete set with 1/4" and 1/2" baton ratchets. 65-piece. For imperial sizes.



Sockets from 5/32" – 1 3/8". Spark plug sockets 5/8" and 13/16" Screwdriver bits with square drive for slotted, Phillips, TORX (with frontal hole) and Allen screws. Five angled Allen keys from 0.05" to 1/8". Four extensions. Two universal joints. Screwdriver handle with square drive. [See photo for full contents.](#)



NO 23 294

For imperial screw sizes from 5/32" to 1 3/8".

Compact set with 3/8" baton ratchet.

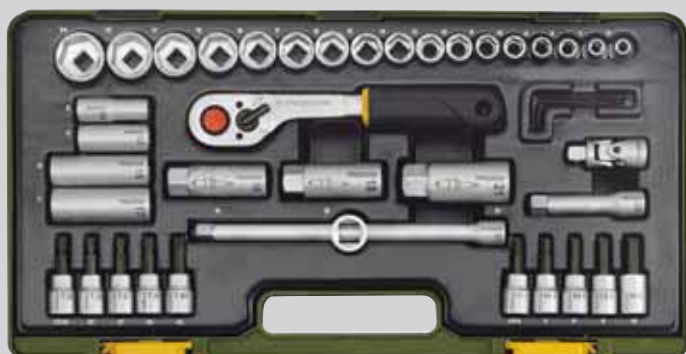

This 44 piece set offers sockets from 6 – 24mm. Deep sockets 10 – 17mm for protruding bolts. Spark plug sockets for 16, 18 and 21mm, T-bar and two extensions. Screwdriver bits with square drive for Allen screws 4 – 10mm and TORX screws (20 – 40). Five angled Allen keys 1.25 – 1.5 – 2.0 – 2.5 and 3mm. [See photo for full contents.](#)

NO 23 282

Including the robust and asymmetrically shaped baton ratchet for heavy duty mechanics with quick-release mechanism at the press of a button. A feature you will appreciate every day.

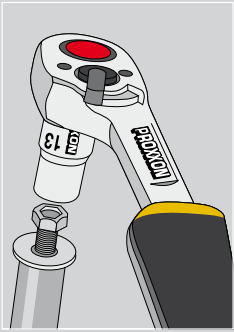

2 year guarantee

For full professional use!

Sockets and drive elements carry an additional **25 year guarantee** against faulty material and workmanship.

Asymmetrical shape improves view when attaching to nut or bolt head.



Perfect teeth, suitably hardened for maximum life expectancy. Reliable drive direction mechanism simultaneously engages numerous teeth to ensure optimal torque.



20 piece special socket set with deep sockets.



With 1/4" square drive (6.3mm)

for torques under 25Nm: hexagonal sockets for 4 – 5 – 5.5 – 6 – 7 – 8 – 9 – 10 – 11 and 12mm.

With 1/2" square drive (12.5mm)

for torques over 25Nm: 13 – 14 – 15 – 16 – 17 – 18 – 19 – 20 – 21 – 22 and 24mm. All parts are matt chrome-plated and are clearly marked with sizes.

See photo for full contents.

NO 23 292

49 piece precision engineer's set with 1/4" baton ratchet.



This set includes sockets from 4 – 13mm, deep sockets from 6 – 10mm for protruding bolts and screwdriver bits with square drive for slotted, Phillips, Allen and TORX (with frontal hole) screws. It also has external TORX sizes 4 – 8, T-bar, 2 extensions, screwdriver handle with square drive and 1.25 – 1.5 – 2.0 – 2.5 and 3mm angled Allen keys.

See photo for full contents.

NO 23 280

41 piece special set for TORX and Allen screws.



With 1/4" square drive (6.3mm)

(for tightening torques up to 25Nm): Screwdriver bits for Allen screws sizes 2 – 6mm and screwdriver bits TX8 – TX40 (with frontal hole) as well as external TORX E4 to E8.

With 1/2" square drive (12.5mm)

(for tightening torques from 25 – 210Nm): Screwdriver bits for Allen screws sizes 7 – 14mm (short version, 55mm) and sizes 6 – 12mm (long version, 100mm), for TORX screws sizes 45 – 60 (short version) and for external TORX sizes E10 to E18. Includes 5 angled head Allen keys in 1.25 – 1.5 – 2.0 – 2.5 and 3.0mm.

See photo at left for full contents.

NO 23 290

If you are looking for the best automotive tool set,

don't waste your time looking further.

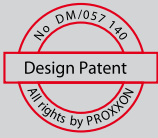

PROXXON
INDUSTRIAL

12 piece matt ring/open-end CrV steel spanners. To DIN 3113.

PROXXON
INDUSTRIAL

Sockets and drive elements made of CrV steel. To DIN 899.

PROXXON
INDUSTRIAL

Reversible ratchet with release mechanism, made from a single steel billet.

High quality, non-crushable, impact resistant case made of oil and acid resistant plastic.



Knipex water pump pliers with through-lock system.



FLEX-DOT screwdrivers. With ergonomically rounded two-component handle and flexible grips for fatigue-free continuous use.



Ball-peen hammer (300g), with graphite handle for superior vibration damping, handy non-slip grip.



High quality combination pliers of CrV steel.



Pocket Allen key set (8 piece set) from 1.5 - 8.0mm.

Automotive and universal tool set Practically equipped with first class tools.

12 piece ring/open end spanner set: 1 piece each in sizes 6 to 15, 17 and 19mm. Knipex 180mm combination pliers. Knipex 240mm water pump pliers. FLEX-DOT screwdriver set: 1 slotted screwdriver each in sizes 8.0 x 1.2 - 5.5 x 1.0 and 3.0 x 0.5mm. 1 Phillips screwdriver, size 2. Including two stubby screwdrivers: 1 size 2 Phillips screwdriver and 1 slotted screwdriver 5.5 x 1.0mm. Automotive light tester with cable and crocodile clip (for automotive electrical systems only).

Sockets, sizes 8 - 10 - 12 - 13 - 14 - 15 - 17 - 19 - 22 and 24mm. Reversible ratchet. Universal joint. 1 each 125 and 250mm extensions. Long T-handle with slide (for loosening wheel nuts). Special 16 and 21mm spark plug sockets with ball head on longer side. Pocket Allen key set (8 piece set) from 1.5 - 8.0mm. PROXXON ball-peen hammer (300g), ground on all sides and partially polished. With inseparable graphite handle (fibre-glass reinforced, non-slip soft coating in grip area) for unparalleled vibration damping.

Each tool has a specific location in the practical plastic lockable carrying case.

NO 23 650

Universal and oil siphoning pump AP 12. Perfect for effortless oil changes in 2 - 3 minutes.

Easily pumps motor, diesel and heating oil. Pump capacity approx. 250l/hr (with 1/2" feed hose). When changing oil with the wand, approx. 3l/min (40°C oil temperature). 200cm long feed line with crocodile clips for battery terminals. Feed and supply side connecting pieces for 1/2" hoses. Includes a wand (approx. 800mm long, outer diameter 6mm) for the oil dipstick shaft, permanently fitted with a reinforced hose. A 1/2" transparent outlet hose, approx. 150cm long, is supplied. Housing of glass fibre reinforced POLYAMIDE, approx. 120 x 90 x 90mm. Approx. weight 1.4kg.

NO 25 262



Note:

The wand fits all vehicles with a 6mm oil dipstick shaft.



1/4"
6.3mm

Ratchets, sockets and accessories for delicate projects.

All of chrome vanadium steel 31 CrV 3.

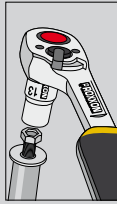

Baton ratchet 1/4". Our sturdy ratchet!

Fine tooth drive: Many teeth of the 45 teeth engage simultaneously for transferring high torques. Reversing lever for ratcheting direction. Quick-release button for ejecting sockets. Head and shaft forged from one CrV steel billet. Double nickel plated with matt chrome plated finish. Grip of oil and acid-resistant TPR (thermoplastic rubber) with practical hole for hanging up.

NO 23 330

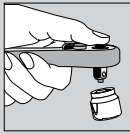

Ratchet 2000 1/4". Our extremely flat ratchet!

Precision ratchet drive for long service life and high torque transmission. Reversing lever for ratcheting direction. Quick-release button for releasing sockets instantly. With handy, soft-touch Dupont HYTREL grip and practical hole for hanging up.

NO 23 170



Standard ratchet 1/4". Proven many times over!

With reversing feature directly on ratchet mechanism. Many of the 52 teeth engage simultaneously for transferring extremely high torques. Quick-release button for ejecting sockets instantly. Head and shaft forged from one piece of CrV steel. Double nickel plated with matt chrome plated finish. Grip of oil and acid-resistant TPR (thermoplastic rubber) with useful hanging hole.

NO 23 092

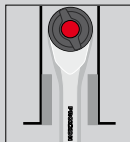

ROTARY ratchet 1/4". With extra offset action!

Rotating the grip enables the stop to be pre-stressed on one side. Just a few millimetres are sufficient for loosening and tightening. Screwing in "idle" occurs through rotation of the grip. Fine tooth drive (52 teeth) with reverse function. Unlocking mechanism: Releases the sockets at the press of a button. For further details see page 17.

NO 23 082



1/4" T-bar with slide

Size Part NO

100mm 23 704



1/4" extension

50mm 23 707
100mm 23 708
150mm 23 705



1/4" flexible extension

150mm 23 706



1/4" universal joint

23 709



1/4" magnetic holder for hexagonal bits
with male and female hex shafts. Ideal for working with electric screwdrivers and drills.

23 703



1/4" drill adapter
for 1/4"-sockets

23 700



1/4" screwdriver handle drive and hole in handle, 140mm long.

140mm 23 702

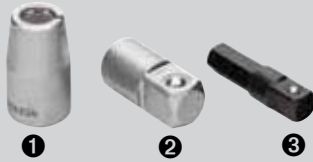

- 1/4" adapter for hexagonal bits** ❶
(DIN 3126) female square to female hexagon
- 1/4" adapter** ❷
1/4" female square to 3/8" male square
- 1/4"-adapter** ❸
with 1/4" male square to 1/4" male hexagon.

23 780
23 782
23 701



1/4" sockets
Made of CrV steel. Total length 25mm.

4mm 23 710
4,5mm 23 711
5mm 23 712
5,5mm 23 713
6mm 23 714
6,5mm 23 715
7mm 23 716
8mm 23 718
9mm 23 720
10mm 23 722
11mm 23 724
12mm 23 726
13mm 23 728
14mm 23 729



1/4" deep sockets
For long protruding bolts.
Made of CrV steel. Total length 50mm.

4mm 23 767
5mm 23 768
5,5mm 23 769
6mm 23 770
7mm 23 772
8mm 23 774
9mm 23 776
10mm 23 778
11mm 23 777
12mm 23 775
13mm 23 779
14mm 23 773



1/4" Allen socket bits, 33mm
Head made of chrome silicon manganese molybdenum steel.
Socket CrV steel.

HX 2mm 23 744
HX 2,5mm 23 746
HX 3mm 23 743
HX 4mm 23 745
HX 5mm 23 747
HX 6mm 23 749
HX 8mm 23 751



1/4" male TORX (TTX) sockets
Made of CrV steel. Total length 25mm.

E 4 23 788
E 5 23 790
E 6 23 792
E 7 23 793
E 8 23 794
E 10 23 796



1/4"-TORX socket bits, 33mm (tamper resistant)
For TORX screws (TX) and safety screws (TTX).
Head made of chrome silicon manganese molybdenum steel. Socket CrV steel.

TTX 5 23 755
TTX 6 23 752
TTX 8 23 753
TTX 10 23 754
TTX 15 23 756
TTX 20 23 758
TTX 25 23 760
TTX 27 23 761
TTX 30 23 762
TTX 40 23 764



1/4" flat screwdriver bits, 33mm
Made of chrome silicon manganese molybdenum steel. Socket CrV steel.

FD 4 mm 23 737
FD 5,5mm 23 739
FD 7 mm 23 741
FD 8 mm 23 742



1/4" Phillips screwdriver bits, 33mm
Made of chrome silicon manganese molybdenum steel. Socket CrV steel.

PH 1 23 730
PH 2 23 731
PH 3 23 732



1/4" Pozidrive bits, 33mm
Made of chrome silicon manganese molybdenum steel. Socket CrV steel.

PZ 1 23 733
PZ 2 23 735

3/8"
10mm

Ratchets, sockets and accessories, handy and compact

for every user! 31 CrV 3 chrome-vanadium steel.

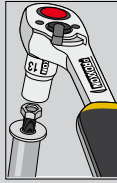

Baton ratchet 3/8". Our sturdy ratchet!

Fine tooth drive: Many of the 54 teeth engage simultaneously for transferring maximum torque. Reversing lever for ratcheting direction. Quick-release button for releasing sockets instantly. Head and shaft forged from one piece of CrV steel. Double nickel-plated with matt chrome-plated finish. Grip of oil and acid-resistant TPR (thermoplastic rubber) with practical hole for hanging up.

NO 23 332

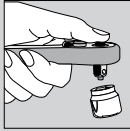

Ratchet 2000 3/8". Our extremely flexible ratchet!

Precision ratchet drive with 44 teeth for long service life and high torque. Reversing lever for ratcheting direction. Quick-release button for releasing sockets instantly. With handy, soft-touch Dupont HYTREL grip and practical hole for hanging up.

NO 23 180

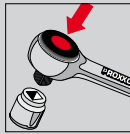

Standard ratchet 3/8". Proven many times over!

With reversing feature directly on ratchet mechanism. Many of the 52 teeth engage simultaneously for transferring extremely high torque. Quick-release button for releasing sockets instantly. Head and shaft forged from one piece of CrV steel. Double nickel-plated with matt chrome-plated finish. Grip of oil and acid-resistant TPR (thermoplastic rubber) with useful hanging hole.

NO 23 094

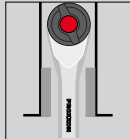

ROTARY ratchet 3/8". With extra offset action!

Rotating the grip enables the stop to be pre-stressed on one side. Just a few millimetres are sufficient for loosening and tightening. Screwing in "idle" occurs through rotation of the grip. Fine tooth drive (52 teeth) with reverse function. Unlocking mechanism: Releases the sockets at the press of a button. For further details see page 17.

NO 23 083



3/8" extension with slide
Adapter to 3/8" male square and 1/2" female square.

Size Part NO

200mm 23 558



3/8" extension

75mm 23 554
150mm 23 556



3/8" universal joint

23 560



3/8" adapter
3/8" female to 1/4" male square (slide for 1/4" extension).

23 564



3/8" adapter
3/8" female square drive to male 1/2" drive (slide for 1/2" extension).

23 566



3/8" drill adapter
for 3/8"-sockets

23 562



3/8" spark plug socket
With TPR (thermoplastic rubber) insert for holding spark plugs. Length 64mm. As above, length 70mm

16mm 23 550
18mm 23 551



3/8" spark plug socket
Hex and double hex (BI-HEX) spark plugs. Slim design (Ø 20mm). With TPR (thermoplastic rubber) insert for holding spark plugs. Length 64mm.

21mm 23 552
14mm 23 553



3/8" sockets
Made of CrV steel.

Size	Part NO
6mm	23 500
7mm	23 502
8mm	23 504
9mm	23 506
10mm	23 508
11mm	23 510
12mm	23 512
13mm	23 514
14mm	23 516
15mm	23 518
16mm	23 520
17mm	23 522
18mm	23 523
19mm	23 524
21mm	23 526
22mm	23 528
24mm	23 530



3/8" deep sockets
for protruding bolts.
Made of CrV steel.
Total length 46mm.

8mm	23 532
9mm	23 534
10mm	23 536
11mm	23 538
12mm	23 540
13mm	23 542
14mm	23 543
15mm	23 544
17mm	23 546
18mm	23 548
19mm	23 549
22mm	23 545
24mm	23 547

As above, total length 64mm.



3/8" Allen socket bits – 50mm
Allen key made of chrome-silicon-manganese-molybdenum steel.
Socket CrV steel.

HX 4mm	23 575
HX 5mm	23 576
HX 6mm	23 578
HX 7mm	23 579
HX 8mm	23 580
HX 10mm	23 581



3/8" TORX socket bits, 50mm
Head made of chrome-silicon-manganese-molybdenum steel. Socket CrV steel.

TX 10	23 583
TX 20	23 584
TX 25	23 585
TX 27	23 586
TX 30	23 587
TX 40	23 588
TX 45	23 589
TX 50	23 590



3/8" flat screwdriver bits, 50mm
Bit made of chrome-silicon-manganese-molybdenum steel. Socket CrV steel.

FD 4 mm	23 591
FD 5,5 mm	23 592
FD 8 mm	23 593

3/8" Phillips screwdriver bits, 50mm
Bit made of chrome-silicon-manganese-molybdenum steel. Socket CrV steel.

PH 1	23 594
PH 2	23 595
PH 3	23 596



PROXXON have been producing fine power tools for about 30 years.
Let us forward our full 60 page catalogue free of charge to you.

There are more than 50 different tools in our range from the light MICRO Engraving Pen GG 12, to our high precision engineering lathe PD400.

PROXXON GmbH
D-54343 Föhren

export@proxxon.com
www.proxxon.com

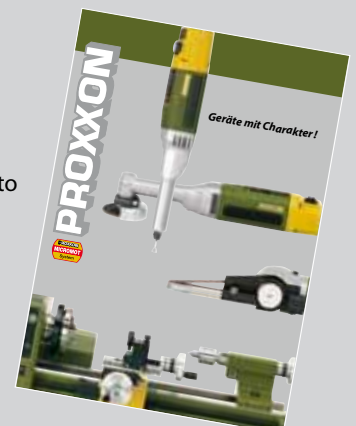

1/2"
12.5mm

Ratchets, sockets and accessories for the most

demanding situations. 31 CrV 3 chrome-vanadium steel.

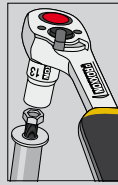

Baton ratchet 1/2". Our sturdy ratchet!

Fine tooth drive: Many of the 52 teeth engage simultaneously for transferring maximum torque. Reversing lever for ratcheting direction. Quick-release button for releasing sockets instantly. Head and shaft forged from one piece of CrV steel. Double nickel-plated with matt chrome-plated finish. Grip of oil and acid-resistant TPR (thermoplastic rubber) with practical hole for hanging up.

NO 23 334

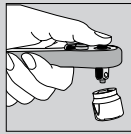

Ratchet 2000 1/2". Our extremely flexible ratchet!

Precision ratchet drive with 44 teeth for long service life and high torque transmission. Reversing lever for ratcheting direction. Quick-release button for releasing sockets instantly. With handy, soft-touch Dupont HYTREL grip and practical hole for hanging up.

NO 23 190



Standard ratchet 1/2". Proven many times over!

With reversing feature directly on ratchet mechanism. Many of the 52 teeth engage simultaneously for transferring extremely high torque. Quick-release button for releasing sockets instantly. Head and shaft forged from one piece of CrV steel. Double nickel-plated with matt chrome-plated finish. Grip of oil and acid-resistant TPR (thermoplastic rubber) with useful hanging hole.

NO 23 096

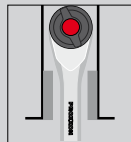

ROTARY ratchet 1/2". With extra offset action!

Rotating the grip enables the stop to be pre-stressed on one side. Just a few millimetres are sufficient for loosening and tightening. Screwing in "idle" occurs through rotation of the grip. Fine tooth drive (52 teeth) with reverse function. Unlocking mechanism: Releases the sockets at the press of a button. For further details see page 17.

NO 23 084



1/2" T-bar extension

With adapter from 1/2" male to 3/8" female.

Size Part NO

250mm 23 457



1/2" extension

64mm 23 452
125mm 23 454
250mm 23 456



1/2" female to 3/8" male square drive
(sliding part for 3/8" extension)

23 458



1/2" universal joint

23 450



1/2" drill adapter
for 1/2" sockets

23 460

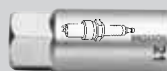

1/2" spark plug sockets

With TPR (thermoplastic rubber) insert for holding spark plugs. Length 65mm.
As above, length 70mm

16mm 23 442
18mm 23 443
19mm 23 445
21mm 23 444



1/2" magnetic spark plug sockets

A powerful permanent magnet allows for easy attaching and firm hold of the spark plug.
Length 65mm.

16mm 23 392

As above, length 70mm
18mm 23 394
21mm 23 396

	Size	Part NO						
	1/2" slotted screw bits, 55mm Chrome-silicon-manganese-molybdenum steel. CrV steel socket.	FD 8mm 23 462 FD 10mm 23 464						
		1/2" Phillips screw bits, 55mm Chrome-silicon-manganese-molybdenum steel. CrV steel socket.	PH 2 23 470 PH 3 23 472 PH 4 23 474					
	1/2" sockets With reduced drive and diameter (19mm and over). Made of CrV steel.	8mm 23 400 9mm 23 402 10mm 23 404 11mm 23 406 12mm 23 408 13mm 23 410 14mm 23 412 15mm 23 414 16mm 23 415 17mm 23 416 18mm 23 417 19mm 23 418 20mm 23 419 21mm 23 420 22mm 23 422 23mm 23 423 24mm 23 424 27mm 23 426 30mm 23 428 32mm 23 430 34mm 23 431 36mm 23 429						
		1/2" deep sockets For protruding bolts. Made of CrV steel. Total length 79mm.	10mm 23 355 11mm 23 356 12mm 23 357 13mm 23 358 14mm 23 359 15mm 23 360 16mm 23 361 17mm 23 362 18mm 23 363 19mm 23 364 21mm 23 365 22mm 23 366 24mm 23 367					
			1/2" Allen socket bits (55mm) Allen key made of chrome-silicon- manganese-molybdenum steel. Socket CrV steel.	HX 5mm 23 476 HX 6mm 23 477 HX 7mm 23 478 HX 8mm 23 479 HX 10mm 23 480 HX 12mm 23 481 HX 14mm 23 482				
				1/2" Allen socket (100mm) Allen key made of chrome-silicon- manganese-molybdenum steel. Socket CrV steel.	HX 5mm 23 484 HX 6mm 23 475 HX 7mm 23 485 HX 8mm 23 486 HX 10mm 23 487 HX 12mm 23 483 HX 14mm 23 468			
					1/2" external TORX socket Made of CrV steel.	E 10 23 380 E 12 23 382 E 14 23 384 E 18 23 388 E 20 23 390		
						1/2" TORX sockets (55mm) Head made of chrome-silicon-manganese- molybdenum steel. Socket CrV steel.	TX 20 23 488 TX 25 23 489 TX 27 23 490 TX 30 23 491 TX 40 23 492 TX 45 23 493 TX 50 23 494 TX 55 23 446 TX 60 23 447	
							1/2" TORX sockets (100mm) Head made of chrome-silicon-manganese- molybdenum steel. Socket CrV steel.	TX 40 23 495 TX 45 23 496 TX 50 23 497 TX 55 23 498 TX 60 23 499

Sockets for XZN (splines) screws are featured on page 16.

1/2"
12.5mm

Ratchets, sockets and accessories, handy and compact

for every user! 31 CrV 3 chrome-vanadium steel.



1/2" spline inserts (55mm)

for XZN bolts. Bit made of chrome-silicon-manganese-molybdenum steel. Socket CrV steel.

Size	Part NO
VZ 5	23 318
VZ 6	23 319
VZ 8	23 321
VZ 10	23 323
VZ 12	23 325
VZ 14	23 327



1/2" spline inserts (100mm)

for XZN bolts. Bit made of chrome-silicon-manganese-molybdenum steel. Socket CrV steel.

VZ 6	23 370
VZ 8	23 371
VZ 9	23 376
VZ 10	23 372
VZ 12	23 373
VZ 14	23 374

1/2" sockets for XZN-screws, 12-pt
Made of CrV steel.

9mm	23 304
10mm	23 305
12mm	23 307
18mm	23 311
19mm	23 312
21mm	23 314

Extra long bar with universal joint and ratchet mechanism (1/2")



The 43cm long bar allows for effortless loosening of tightly locked screws. Made of CrV steel, matte chrome finish. Robust ratchet mechanism with reversing lever (60 teeth). Grip made of oil and acid-resistant TPR (thermoplastic rubber).

NO 23 090

IMPACT socket set for wheel nuts. Sockets with plastic cover and plastic stop insert prevent damage to aluminium wheel rim surface.



For use with pneumatic screwdrivers 1/2" (12.5mm). High alloy special steel for superior wear resistance and a maximum torque of 500Nm. Extra long (85mm). In sturdy steel box (powder coated).

NO 23 938 1 piece each 17 – 19 and 21mm

IMPACT sockets (individually), as described above

NO 23 962 Size 17
NO 23 964 Size 19
NO 23 966 Size 21



ROTARY ratchets 1/4", 3/8" and 1/2" square drive.

With extra offset action through rotating handle.

The perfect tool when space is a problem: at heating and cooling systems, servomotors and exhaust systems. Also auto gearboxes.

The rotating handle allows the loosening and tightening of items with just millimetres to spare. Fine tooth drive (52 teeth) ensures normal ratchet function. The unlocking mechanism releases the socket at the press of a button. Reversible function. Handy grip of two component material, ergonomically engineered to be used with ease.

Drive

NO 23 082	ROTARY ratchet 1/4"	6.3mm
NO 23 083	ROTARY ratchet 3/8"	10mm
NO 23 084	ROTARY ratchet 1/2"	12.5mm



2 year guarantee

For full professional use!

With 1/4" (6.3mm) adapter in handle to fit an extension. If properly used, a lever may also be fitted here (ratchet, T-bar).

Workshop special sets for long bolts and screws. With forged, short tubular hexagon box spanners and externally gripping ratchet.



Fitting shock absorbers usually requires a 22mm socket.



The pulley on an alternator will usually have a 24mm nut.

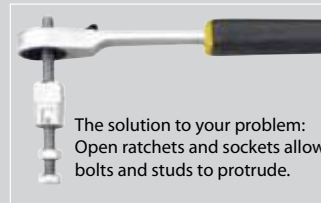

The solution to your problem: Open ratchets and sockets allow bolts and studs to protrude.

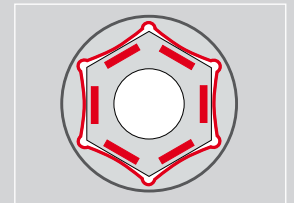

The *Driver-System*: The driving force is applied to the flanks, not the corners.

14-piece special set 13 to 27mm

With reversible ratchet, TPR (thermoplastic rubber) grip, 55mm extension (open construction as well) and adapter with 1/2" square (12.5mm). In robust steel box (powder coated) with strong plastic tray.

NO 23 604

13-piece special set 5.5 to 14mm

With reversible ratchet, TPR (thermoplastic rubber) grip, 55mm extension (open construction as well) and adapter with 1/4" (6.3mm) square. In robust steel box (powder coated) with strong plastic tray.

NO 23 602



2 year guarantee

For full professional use!

Sockets and drive elements carry an additional **25 year guarantee** against faulty material and workmanship.

The new MicroClick torque wrench with automatic release torque signalled by a click

High accuracy as to ISO 6789: +/- 3 %. Now with fine adjustment.

PROXXON

INDUSTRIAL

Ratchet mechanism with reversing lever for clockwise and anticlockwise rotation. Automatic release: Clearly audible and palpable click signal when selected torque is reached.



Clearly legible analogue display for simple pre-selection of the desired torque.

Ergonomically shaped handle allows for automatically gripping it in a centric position. Important for obtaining an exact release torque.

Additional micro-scale for fine adjustment.

Simple pre-setting of the torque by turning the knurled ring at the end of the handle, fixing it by sliding it into position.

Practical release mechanism: the socket is securely fixed and automatically released at the push of the button.

Sturdy, oval steel shaft with rust-protective finish: double nickel and subsequent matt-finished chrome-plating.

Torque wrench MicroClick MC 320

For 60 – 320Nm. With 1/2" square drive (12.5mm). Total length 610mm. Otherwise as described above.
NO 23 354

MicroClick MC 200

For 40 – 200Nm. With 1/2" square drive (12.5mm). Total length 530mm. Otherwise as described above.
NO 23 353

MicroClick MC 100

For 20 – 100Nm. With 3/8" square drive (10mm). Total length 430mm. Particularly suitable for motorcycles. Otherwise as described above.
NO 23 351

MicroClick MC 30

For 6 – 30Nm. With 1/4" square drive (6.3mm). Total length 310mm. Otherwise as described above.
NO 23 349

MC 320

MC 200

Piece by piece calibration and final inspection. With permanent laser-marked serial number identifying the product.



2 year guarantee

For full professional use!

instinct click.

Automatic quick



MicroClick torque wrenches are precision tools. They are packaged in a sturdy and practical plastic storage box.



Reversing lever for clockwise and anticlockwise rotation.

MC 100

MC 30

Piece by piece calibration and final inspection. With permanent laser-marked serial number identifying the product.



MM	HEX	INHEX	FM-TX	M-TX	Nm
M 1,6	3,2	SW 1,5			-
M 2	4	SW 2	TX 6		-
2 - 2,5			TX 7		-
M 2,5	5	SW 2	TX 8		-
2,9 - 3			TX 9		-
M 3	5,5	SW 2,5	TX 10	E 4	-
(M 3,5)	6	-	TX 15		-
M 4	7	SW 3	TX 20	E 5	3
M 5	8	SW 4	TX 25	E 6	5,9
4,5 - 6			TX 27		-
M 6	10	SW 5	TX 30	E 8	10
(M 7)	11	-	TX 40		-
M 8	13	SW 6	TX 40	E 10	25
8-10			TX 45		-
M 10	(16) 17	SW 8	TX 50	E 12	49
M 12	(18) 19	SW 10	TX 55	E 14	85
(M 14)	(21) 22	SW 12	TX 60	E 18	135
M 16	24	SW 14	TX 70	E 20	210
(M 18)	27	SW 14	TX 80	E 24	300
M 20	30	SW 17	TX 90	E 24	425
(M 22)	(34) 32	-			580
M 24	36	SW 19			740

Tightening torques for bolt shanks with standard metric threads (DIN 13, Part 13) and head contact dimensions (DIN 912, 931, 934). The coefficient of friction was determined using an untreated and unplated bolt (ungreased, lightly oiled).

© by PROXXON



Torque wrench MicroClick MC 200-Multi For 40 – 200Nm. With 10 plug-on tools.



Allows for torque controlled tightening of screws and sleeves on pipe connections, hydraulic systems, pneumatic pipelines, threaded rods. A problem solver when space does not allow for the tool to be fitted from the top. For lateral access and working when space is at a premium.

10 plug-on tools with square joint (14 x 18mm) to safely lock into position via spring bolt: 9 open-end spanners, forged of CrV steel, available in sizes 13 – 14 – 15 – 17 – 19 – 22 – 24 – 27 and 30mm. The ratcheting head with 1/2" square drive (12.5mm) turns the MicroClick 200-Multi into a normal torque wrench for sockets.

Configuration and technology otherwise like MicroClick MC 200 and series (see left).

NO 23 342

Note:

Our torque screwdriver MicroClick MC 5 (1.0 – 5.0Nm) is featured on page 27.

MicroSpeeder with ratchet function at the ring end.

Extra long design.

PROXXON
INDUSTRIAL

2 year guarantee

For full professional use!

Old generation spanners cannot be repositioned: here the Speeder's ratchet function takes over.

The 72-tooth inner ring gear, made of special high alloy steel, allows ratcheting even when the spanner can only be moved through 5°. Nevertheless, the torque transmission capacity far exceeds the DIN/ISO standards and this enables the longer design. CrV steel shaft, chrome-plated, with a satin finish to pamper your hands. Clear, laser inscribed sizes avoid any confusion.



The fully encapsulated drive is perfectly functional.



The extremely compact exterior measurements (A+B) and very slender head offer superior accessibility.



MicroSpeeder with lever for direction change and 15° ring offset. Extra long design. No swopping over: a real time saver!



The 15° ring offset might make the turning over of the spanner impossible. For this instance, the direction change lever solves the problem. The spanner is ideally suited for working on flat surfaces.

MicroSpeeder with reversing lever, individually

NO 23 130	Size 8
NO 23 131	Size 9
NO 23 132	Size 10
NO 23 133	Size 11
NO 23 134	Size 12
NO 23 135	Size 13
NO 23 136	Size 14
NO 23 137	Size 15
NO 23 138	Size 16
NO 23 139	Size 17
NO 23 140	Size 18
NO 23 141	Size 19
NO 23 143	Size 21
NO 23 144	Size 22
NO 23 146	Size 24

MicroSpeeder set, 7-piece

One each 8 – 10 – 13 – 16 – 17 – 18 and 19mm in a sturdy powder coated steel box.

NO 23 124



With 15° ring offset, thus ideally suited for working on flat surfaces.

No swopping over of the spanner: a real time saver.

**MicroSpeeder with straight, slender and extra long design.
Ideal for inserting into tight spaces.**



When things get really tight, the *MicroSpeeder* is superior. Often used on automatic transmissions for removing engines, on rear axles, etc. Mechanics often carry the sizes 10 x 13 and 17 x 19 with them.

NO 23 241 Size 8 x 9
NO 23 243 Size 10 x 11
NO 23 244 Size 10 x 13
NO 23 246 Size 12 x 13

NO 23 247 Size 14 x 15
NO 23 249 Size 16 x 18
NO 23 250 Size 17 x 19
NO 23 252 Size 22 x 24

Hinged MicroSpeeder with up to 90° swivelling ring action. For work without swopping over of the spanner. Extra long design.



The self positioning action of the ring means extreme ease of use, even after being used many times over. The spanner's flexibility remains unmatched. The self positioning action of the ring is ideal for tight locations.

Hinged MicroSpeeder, individually

NO 23 045 Size 8mm
NO 23 046 Size 9mm
NO 23 047 Size 10mm
NO 23 048 Size 11mm
NO 23 049 Size 12mm
NO 23 050 Size 13mm
NO 23 051 Size 14mm
NO 23 052 Size 15mm
NO 23 053 Size 16mm
NO 23 054 Size 17mm
NO 23 055 Size 18mm
NO 23 056 Size 19mm
NO 23 058 Size 21mm
NO 23 059 Size 22mm
NO 23 061 Size 24mm

Hinged MicroSpeeder, 7-piece.

One each 8, 10, 13, 16, 17, 18 and 19mm of the long version, in a sturdy powder coated steel box.

NO 23 068

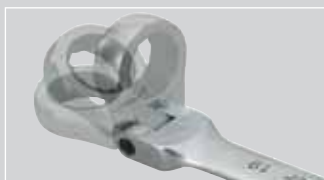

Inversible joint:
Unbeatable in tight places!

Standard Speeder ratchet spanners. With reversing lever.

Easy, handy and especially practical for installation work.

SPEEDER set for hex head bolts. 6-piece

Spanners from 6 – 19mm. Sizes 6x7, 8x9, 10x11, 12x13, 14x15 and 17x19mm. The set comes in a powder coated sturdy steel carry case.

NO 23 231



DIN
ISO

2 year guarantee

For full professional use!

Premium adjustable wrenches!
Precision and ergonomics for powerful universal application.
To DIN 3117 / ISO 6787.



Made of hot-forged CrV steel. Ergonomic grip of extremely sturdy carbon fibre reinforced plastic (with hole). Slim head with ground jaws and an opening position of 22.5°. Easy to read millimetre scale for sizes and for measuring. Accurate control of flexible jaw with smooth-running adjustment via milled screw.

2 year guarantee

For full professional use!

also indicates length

	in mm	jaw width
NO 23 990	RG 200	24.5mm
NO 23 992	RG 250	29.0mm
NO 23 994	RG 300	34.0mm

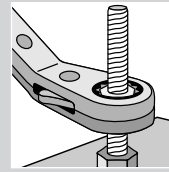

Gap allows long bolts to pass through when tightening the nut.

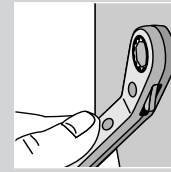

Head offset 25° for advantageous handling.

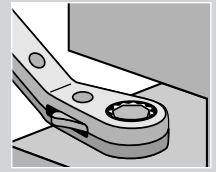

The SPEEDER shows its strengths in close quarters.

Speeder ratchet spanners, individually

NO 23 201	Size	6 x 7
NO 23 204	Size	8 x 9
NO 23 205	Size	10 x 11
NO 23 207	Size	10 x 13
NO 23 209	Size	12 x 13
NO 23 211	Size	14 x 15
NO 23 214	Size	16 x 18
NO 23 215	Size	17 x 19
NO 23 216	Size	19 x 21

SlimLine spanners, packed in cardboard-box.
Complete for sizes 6 – 32mm. Assembly as described on the right.



10 year guarantee

For full professional use!

SlimLine open-end spanner set, 11-piece.

Sizes 6 x 7, 8 x 9, 10 x 11, 12 x 13, 14 x 15, 16 x 17, 18 x 19, 20 x 22, 21 x 23, 24 x 27 and 30 x 32mm. In a cardboard box.

NO 23 802

SlimLine combination spanner set, 21-piece.

Sizes 6 – 7 – 8 – 9 – 10 – 11 – 12 – 13 – 14 – 15 – 16 – 17 – 18 – 19 – 20 – 21 – 22 – 24 – 27 – 30 and 32mm. In a cardboard box.

NO 23 822

SlimLine double ring spanner set, 11-piece.

Sizes 6 x 7, 8 x 9, 10 x 11, 12 x 13, 14 x 15, 16 x 17, 18 x 19, 20 x 22, 21 x 23, 24 x 27 and 30 x 32mm. In a cardboard box.

NO 23 812

SlimLine spanners. Hands-on tools. CrV steel drop forged, carefully hardened and plated. With clearly readable sizes.

- Optimal surface protection by means of double nickel-plating and single chrome-plating. With easy to hold, smooth finish.
- Polished heads: slim and thin walled. Torque characteristics still exceed DIN/ISO requirements.
- New: Now with durable laser inscribed and clearly readable sizes in mm.
- Dimensional tolerances are better than those required by DIN/ISO. Each piece is calibrated and checked.

SlimLine - open-end spanners: 8-piece set complete with holder. To DIN 3110 and ISO 3318.

Includes 6 x 7, 8 x 9, 10 x 11, 12 x 13, 14 x 15, 16 x 17, 18 x 19 and 20 x 22mm. Supplied with a plastic holder with slot for each spanner and holes for attaching to a wall. All spanners clearly labelled to make them easy to find.

NO 23 800 as above

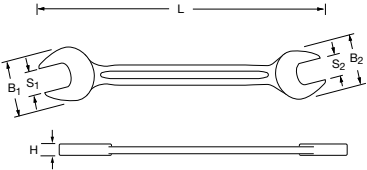

PROXXON INDUSTRIAL		SlimLine-open-end spanners, individually				
	S ₁ x S ₂	B ₁	B ₂	L	H	
23 828	5 x 5,5 mm	13	14	111	3	
23 830	6 x 7 mm	16	18	123	3,4	
23 832	8 x 9 mm	20	22	140	3,5	
23 834	10 x 11 mm	24	26	157	4,5	
23 836	12 x 13 mm	28	29	173	4,7	
23 838	10 x 13 mm	24	29	174	4,7	
23 840	14 x 15 mm	32	34	190	5,5	
23 842	16 x 17 mm	36	38	205	6,0	
23 846	18 x 19 mm	38	42	220	6,5	
23 848	17 x 19 mm	38	42	220	6,5	
23 850	20 x 22 mm	43	46	235	7,5	
23 852	21 x 23 mm	45	48	248	7,5	
23 856	24 x 27 mm	49	55	268	8,5	
23 860	30 x 32 mm	59	64	302	9,5	
23 864	34 x 36 mm	65	79	320	10,0	
23 866	41 x 46 mm	86	95	415	15,0	

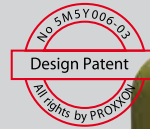

For full professional use!

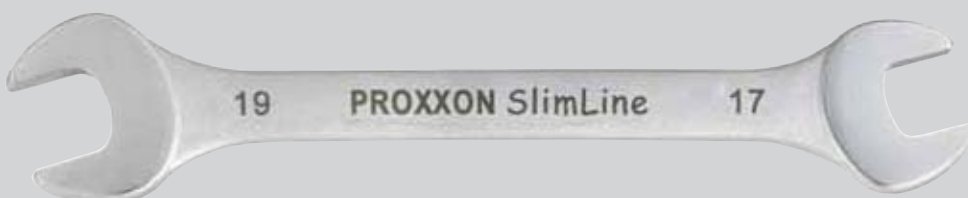

SlimLine spanners. Tools to get to grips with. CrV steel drop forged, carefully

hardened and plated. With clearly readable sizes.

10 year guarantee



For full professional use!

Each spanner has a clearly marked place for storage. The plastic holder also offers holes to allow it to be fixed to a wall.

**SlimLine - Double ring spanners:
8-piece set. To DIN 838 and ISO 3318
with 75° offset heads.**

Sizes 6 x 7, 8 x 9, 10 x 11, 12 x 13, 14 x 15, 16 x 17, 18 x 19 and 20 x 22mm.

Each spanner has a clearly marked place for storage. The plastic holder also offers holes to allow it to be fixed to a wall.

NO 23 810 set complete

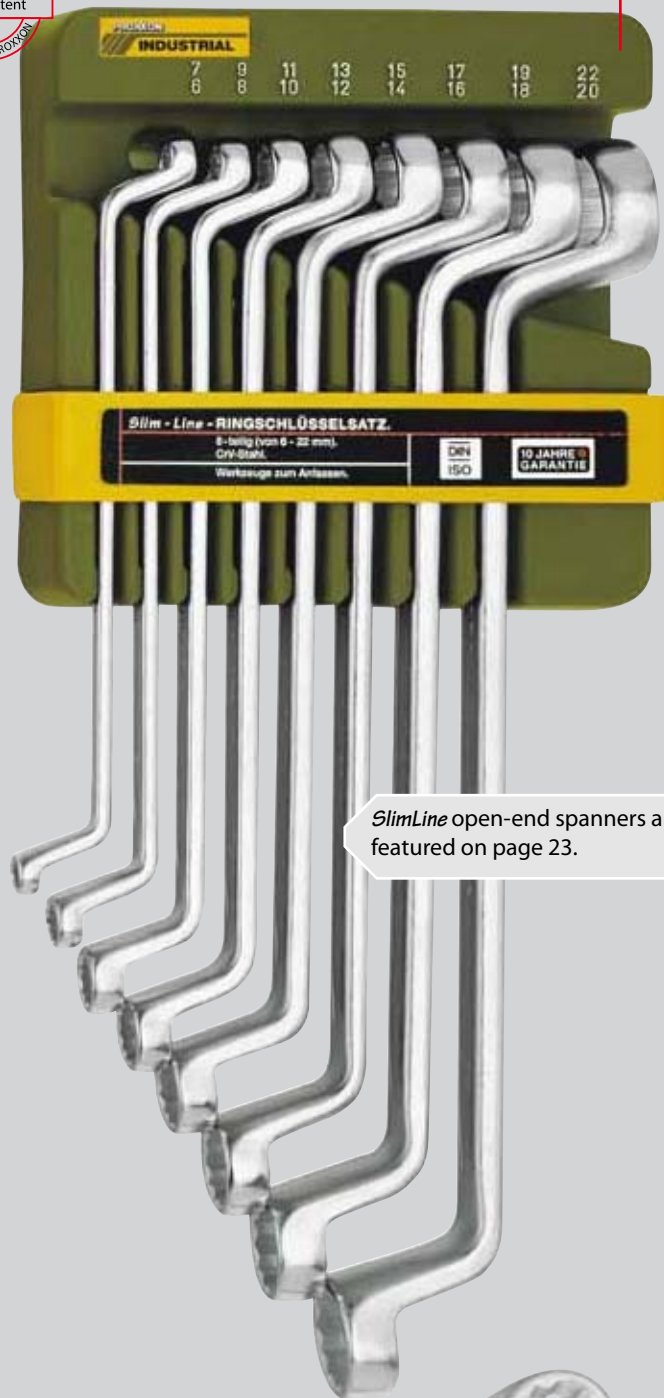
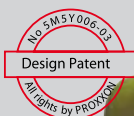

SlimLine open-end spanners are featured on page 23.



PROXXON INDUSTRIAL SlimLine double ring spanners, individually

	S ₁ x S ₂	B ₁	B ₂	L	H
23 868	5 x 5,5 mm	9	10	162	5
23 870	6 x 7 mm	10	12	173	5,6
23 872	8 x 9 mm	13	14	182	6,1
23 874	10 x 11 mm	16	17	200	7,9
23 876	12 x 13 mm	18	19	212	8,5
23 878	10 x 13 mm	16	19	212	8,5
23 880	14 x 15 mm	21	23	225	9,8
23 882	16 x 17 mm	24	25	245	10,4
23 886	18 x 19 mm	27	28	260	11,3
23 888	17 x 19 mm	25	28	216	11,3
23 890	20 x 22 mm	30	32	285	12,8
23 892	21 x 23 mm	31	33	310	12,9
23 896	24 x 27 mm	34	38	335	13,9
23 900	30 x 32 mm	42	45	375	15,3

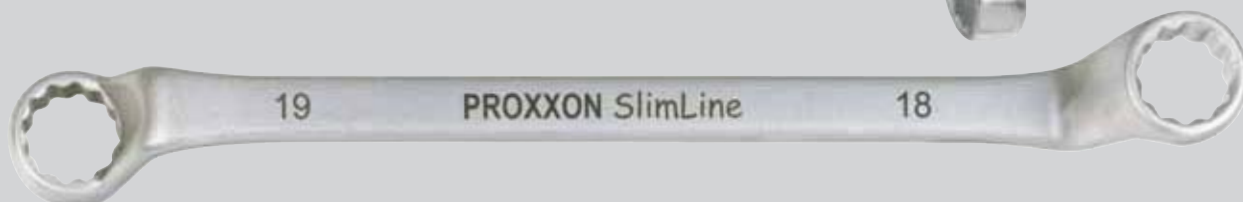

SlimLine spanners. Tools to get to grips with. CrV steel drop forged, carefully

hardened and plated. With clearly readable sizes.

**SlimLine Ring-combination spanner set
12-piece. Complete with holder. To DIN 3113
and ISO 3318 (ring head offset 15°).**

Sizes 6 – 7 – 8 – 9 – 10 – 11 – 12 – 13 – 14 – 15 – 17 and 19mm. Each spanner has a clearly marked place for storage. The plastic holder also offers fixing holes.

NO 23 820 set complete

**SlimLine combination spanner set
15-piece. With the new ISO sizes 16, 18 and
21mm. Otherwise as described on the left.**

Sizes 6 – 7 – 8 – 9 – 10 – 11 – 12 – 13 – 14 – 15 – 16 – 17 – 18 – 19 and 21mm.

NO 23 821 set complete

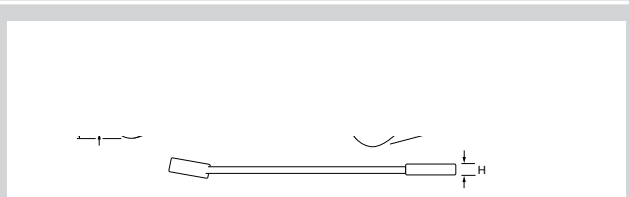

	S₁	B₁	B₂	L	H
23 905	5,5 mm	9	14	93	3
23 906	6 mm	10	16	100	3,4
23 907	7 mm	12	18	110	3,4
23 908	8 mm	13	20	120	3,5
23 909	9 mm	15	22	130	3,5
23 910	10 mm	16	24	140	4,5
23 911	11 mm	17	26	150	4,5
23 912	12 mm	19	28	160	4,7
23 913	13 mm	20	29	170	4,7
23 914	14 mm	22	32	180	5,5
23 915	15 mm	24	34	190	5,5
23 916	16 mm	25	36	195	6,0
23 917	17 mm	25	38	210	6,0
23 918	18 mm	28	38	216	6,5
23 919	19 mm	28	42	230	6,5
23 920	20 mm	30	46	250	7,5
23 921	21 mm	32	45	245	7,5
23 922	22 mm	33	46	270	7,5
23 924	24 mm	36	49	280	8,5
23 927	27 mm	39	55	310	8,5
23 930	30 mm	44	59	340	9,5
23 932	32 mm	46	64	360	9,5
23 933	34 mm	50	70	380	15
23 935	36 mm	54	74	410	18
23 937	41 mm	61	84	460	21



Super Safety and Special Bit Set.

Nothing is Impossible to Unscrew.

2 year guarantee

For full professional use!
Bits and adapters carry an additional **25 year guarantee** against faulty material and workmanship!

Deep hole bits (80mm) ■
Normal bits (25mm) ■

Claw keys.
No. 6, 8.

Bits for slotted screws
3.0 and 5.5mm.

PH 1 and 2.

Allen key bits with countersink. 4 and 5mm.

TORX bits with countersink (tamper resistant). TX 10, TX 15, TX 20, TX 30.

TORX bits with countersink (tamper resistant). 12 pcs, from TX5 to TX40.

Allen key bits with interior hole. **Metric** 7 pieces from 2 - 8mm.

TRI-WING bits. TW1, 2 and 3.

Male square drive bits SQ00, SQ01, SQ02 and SQ03.

3 Clutch sockets: C1, C2, C3.

Allen key bits with countersink. **Imperial.** 6 pieces from 5/64" to 5/32".

TRI-WING bits. 5 pieces from TW1 - TW5.

TORQ-set bits TS6, TS8 and TS10.

Allen key bits with countersink. **Imperial.** 6 pieces from 5/64" to 5/32".

Claw keys. 5 pieces No. 4 - No. 12.

XZN multi-toothed bits sizes 5, 6 and 8.

For completeness' sake, 7 useful bits (PH, PZ and for flats).

Super safety and specialty bit set, 1/4" drive (6.3mm). 75-piece.

Industrial quality tool set of special chrome-molybdenum-silicon-manganese-vanadium steel alloy. Sizes and shapes as described above. Including screwdriver with positive spring-sleeve holder for bits. Magnetic holder for work with electric screwdriver or drill. Adapter with male square and male hex drive and matching attachment with female square and female hex drive. Special attachment for centrally

clamping screw hooks and similar parts. All in sturdy steel box with durable powder coated finish. Each part clearly marked and of fixed location.

NO 23 107

Allen (HX) and TORX (TX) key sets.

For highest torques.



Allen key set, 9-piece

With spherical finish on the long end (short end chamfered).
One each 1.5 – 2.0 – 2.5 – 3.0 – 4.0 – 5.0 – 6.0 – 8.0 and 10mm. Chrome-vanadium steel. In foldable plastic holder.

NO 23 946

TORX set, 9-piece

One each TX 8 – 10 – 15 – 20 – 25 – 27 – 30 – 40 and 50. Made from Nickel-Chrome-Molybdenum special steel. In foldable plastic holder.

NO 23 944



Pocket Allen key set, 8-piece

One each 1.5 – 2.0 – 2.5 – 3.0 – 4.0 – 5.0 – 6.0 and 8.0mm. Made from Chrome-Molybdenum special steel, galvanically plated. In pocket knife type plastic holder which also serves as a handle.

NO 23 956



Pocket TORX key set, 8-piece

One each TX 9 – 10 – 15 – 20 – 25 – 27 – 30 and 40. Made from Nickel-Chrome-Molybdenum special steel. In pocket knife type plastic holder which also serves as a handle.

NO 23 954

Torque Screwdriver MicroClick MC5 (1.0 – 5.0Nm)

With analogue display, micro scale for fine adjustment and self-locking bit adapter.

Automatic quick-release when tightening screws: Clearly audible „click“, if the set torque has been reached. Infinitely variable ring at the end of the handle to preselect the desired torque. Ring is pushed in to block the set position. Clearly legible scale with window. With 1/4" square (6.3mm) for drive of standard 1/4" (6.3mm) bits which are clamped in a spring release chuck. The kit is supplied in a sturdy plastic case.

NO 23 347



Practical plastic case for storage of this precision tool is included in the scope of delivery.

Note:

Torque wrenches MicroClick are featured on pages 18 and 19!

Self-locking adapter for holding 1/4" (6.3mm) standard bits in a form fitting manner.

Additional micro scale for fine adjustment: 1 rotation = 1.0Nm, scale ring with 0.10Nm graduation.

2 year guarantee

For full professional use!



FLEX-DOT screwdrivers. The allrounders for workshop and assembly.

PROXXON

INDUSTRIAL

Ergonomic design for proper handling:

Rounded two-component handle and flexible "FLEX-DOT" nubs for fatigue-proof and comfortable continuous use. Excellent grip attitude also with quick regripping. Combines high torques and pressure forces with balanced design for horizontal and vertical approach.

DIN
ISO

2 year
guarantee

For full professional use!



Blade symbol and size at end of grip for better identification.

With transverse hole for hanging up or applying a lever.

Oil- and acid resistant non-stick special rubber handle.

Finger recesses for more grip during fast turning.

Easy to read sizes through laser marking process on matte-chrome plated shafts of chrome silicon manganese molybdenum alloy special steel.

Continuously hardened and stress-relieved with a balanced ratio of torsional rigidity and toughness.

Processed black tip for greatest precision for accepting screws. Also prevents tool from slipping.

Popular screwdriver combinations for daily use.

FLEX-DOT 6-piece screwdriver sets

Combinations that are a must-have for every tool box. Complete initial equipment for mechanics and service technicians.

NO					
22 604		3,0	4,0	5,5	6,5
		PH 1	PH 2		
22 606		3,0	4,0	5,5	6,5
		PZ 1	PZ 2		
22 640		TTX 10	TTX 15	TTX 20	TTX 25
		TTX 30	TTX 40		
22 642		HX 2,5	HX 3	HX 4	HX 5
		HX 6	HX 8		
22 644		HEX	5,5	6	7
			8	10	13



Note: Our insulated screwdriver set is featured on page 30.

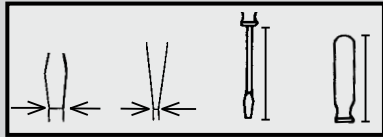

2 year guarantee

For full professional use!



Slotted screwdrivers

NO	mm	mm	mm	mm
22 010	3,0	0,5	100	75
22 012	4,0	0,8	100	75
22 014	5,5	1,0	125	100
22 016	6,5	1,2	150	110
22 018	8,0	1,2	175	122
22 020	10,0	1,6	200	122
22 026	5,5	1,0	25	60

- ①
- ①
- ①
- ②
- ② ③
- ② ③
- ①



Matte-chrome plated blades of chrome vanadium special steel, with precision black tip.



PHILLIPS screwdrivers

NO	PH	mm	mm
22 050	0	60	75
22 052	1	80	100
22 054	2	100	110
22 056	3	150	122
22 060	2	25	60

- ③

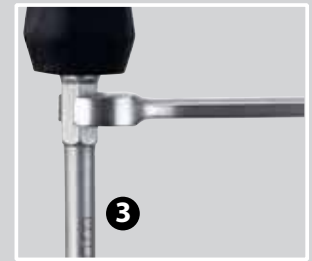

With hexagon flat for applying an open-end spanner as lever (important for tightly-seated screws).



POZIDRIV Phillips screwdrivers

NO	PZ	mm	mm
22 070	0	60	75
22 072	1	80	100
22 074	2	100	110
22 076	3	150	122

- ③

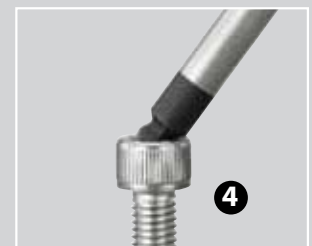

Difficult to access Allen screws can be screwed at a working angle of up to 25° with HEX.

- ④



HEX (ball head) screwdrivers

NO	HEX	mm	mm
22 204	2	100	75
22 206	2,5	100	75
22 208	3	100	75
22 210	4	100	100
22 212	5	100	110
22 214	6	150	110
22 216	8	150	122



Professional screwdrivers for industrial and commercial use.

**2 year
guarantee**

For full professional use!

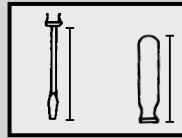

TTX Tamper TORX screwdrivers (with frontal hole)

NO	TTX	mm	mm
22 230	8	75	75
22 232	10	100	100
22 234	15	100	100
22 236	20	100	100
22 238	25	100	110
22 240	27	100	110
22 242	30	100	110
22 244	40	100	110



HEX nut screwdrivers

NO	HEX	mm	mm
22 260	5,5	125	110
22 262	6	125	110
22 264	7	125	110
22 266	8	125	110
22 268	9	125	110
22 270	10	125	110
22 272	11	125	110
22 274	12	125	110
22 276	13	125	110

Insulated FLEX-DOT screwdrivers according to VDE standard

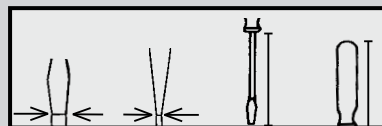

Insulated slotted screwdrivers



NO	mm	mm	mm	mm
22 300	2,5	0,4	75	75
22 304	4,0	0,8	100	100
22 306	5,5	1,0	125	100
22 308	6,5	1,2	150	110

Insulated PHILLIPS screwdrivers

NO	PH	mm	mm
22 330	0	60	75
22 332	1	80	100
22 334	2	100	110

Insulated VDE screwdrivers for work on or around live components up to 1.000V AC. Injection of the protective insulation onto the screwdriver blade and piece by piece inspection offer maximum safety.

Insulated VDE screwdriver set

NO		mm	mm	mm	mm
22 630		2,5	4,0	5,5	6,5
		PH 1	PH 2		

L-handle screwdrivers: Very robust with continuous blade.

PROXXON

INDUSTRIAL

If high torques are required for tightening or loosening screws, the L-handle screwdriver is the solution. The ergonomic and asymmetrical grip simplifies handling under continuous operation. Its two-component design with soft zones reduces pressure marks while at the same time allowing for optimum torque transfer.

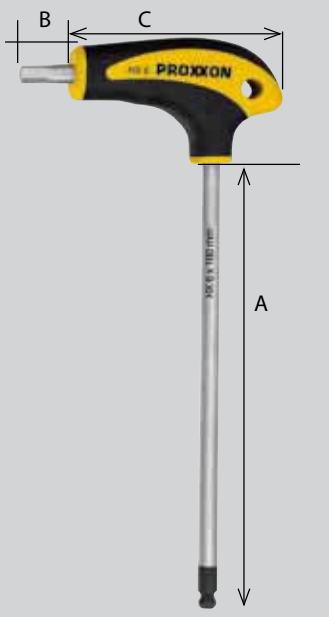

L-handle HEX screwdrivers

Short blade with sturdy standard HEX, long blade with HEX ball (ball head).

NO	HEX	A mm	B mm	C mm
22 402	2	110	15	55
22 404	2,5	110	15	55
22 406	3	110	15	55
22 408	4	110	15	55
22 410	5	160	20	75
22 412	6	160	20	75
22 414	7	160	20	75
22 416	8	200	20	75
22 418	10	215	20	100

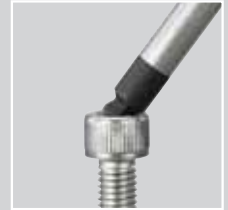

Difficult to access Allen screws can be screwed at a working angle of up to 25° with HEX Ball.

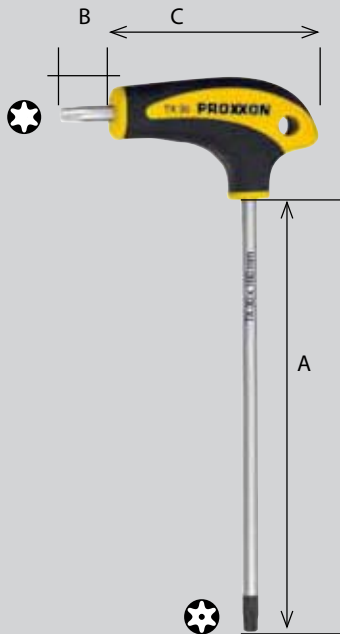

L-handle TORX screwdrivers

Short blade with sturdy standard TORX TX, long blade with Tamper TORX TTX

NO	Torx	A mm	B mm	C mm
22 440	8	110	15	55
22 442	9	110	15	55
22 444	10	110	15	55
22 446	15	110	15	55
22 448	20	110	15	55
22 450	25	160	20	75
22 452	27	160	20	75
22 454	30	160	20	75
22 456	40	185	20	75
22 458	45	215	20	100
22 460	50	215	20	100



When using the screw socket of the short blade, the longer shank is used as „lever“ for extreme torque.

2 year guarantee

For full professional use!

DIN
ISO

L-handle screwdriver sets

With versatile holder for the workshop. Clear specified sizes on the holder for neat storage of L-handle screwdrivers.

NO	Contents
22 650	8-piece L-handle HEX set with holder HX 2 – 2,5 – 3 – 4 – 5 – 6 – 8 – 10
22 652	10-piece L-handle TX set with holder TX 8 – 10 – 15 – 20 – 25 – 27 – 30 – 40 – 45 – 50



Contents

	<i>Page/Pages</i>
	<i>Socket sets and tool sets</i> 3 – 9
	<i>Ratchets, socket sets and drive elements</i> 10 – 16
	<i>IMPACT sockets for wheel nuts</i> 16
	<i>Special tools and problem solvers</i> 17
	<i>Torque wrenches MicroClick</i> 18 – 19
	<i>MicroSpeeder and speeder ratchet spanners</i> 20 – 22
	<i>Adjustable spanners</i> 22
	<i>SlimLine spanners</i> 22 – 25
	<i>Special bits (including HX and TX)</i> 26 – 27
	<i>Torque screwdriver MicroClick MC 5</i> 27
	<i>FLEX-DOT screwdrivers</i> 28 – 31
	<i>Universal and oil suction pump AP 12</i> 9

PROXXON GmbH

Industriepark Region Trier • Dieselstraße 3 - 7 • D-54343 Föhren
 Tel. + 49 (0) 65 02 – 93 17 – 0 • Fax + 49 (0) 65 02 – 93 17 – 200
 e-mail export@proxxon.com • www.proxxon.com